



Steam Specialties Vacuum Breakers

MEPCO Vacuum Breakers are simple and reliable devices that provide a positive means to automatically relieve or “break” unwanted vacuum conditions. The hex design provides a long service life and ease of installation. A tight seal is assured with a soft silicon O-Ring and spring pressure against the valve.

Applications

- Air/Heat Coils for Space Heating
- Process Air Heaters
- Shell & Tube Heat Exchangers
- Make-Up Air Coils
- Textile Dry Cans
- Steam Boilers
- Storage Boilers
- Jacketed Kettles
- Steam Main Zoning
- One Pipe Steam Non-Electric Valve

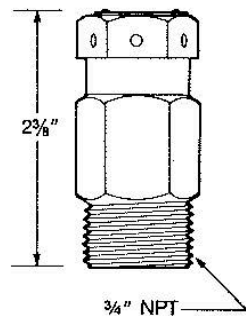
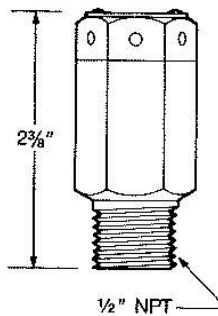
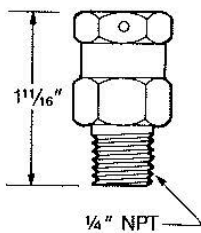
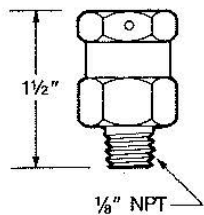
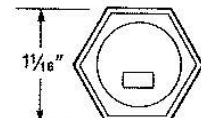
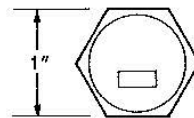
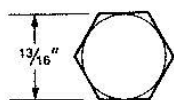
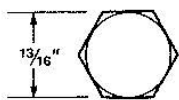

VB 3901

VB 3902

VB 3856

VB 3875

Vacuum Breakers
Engineering
Specifications

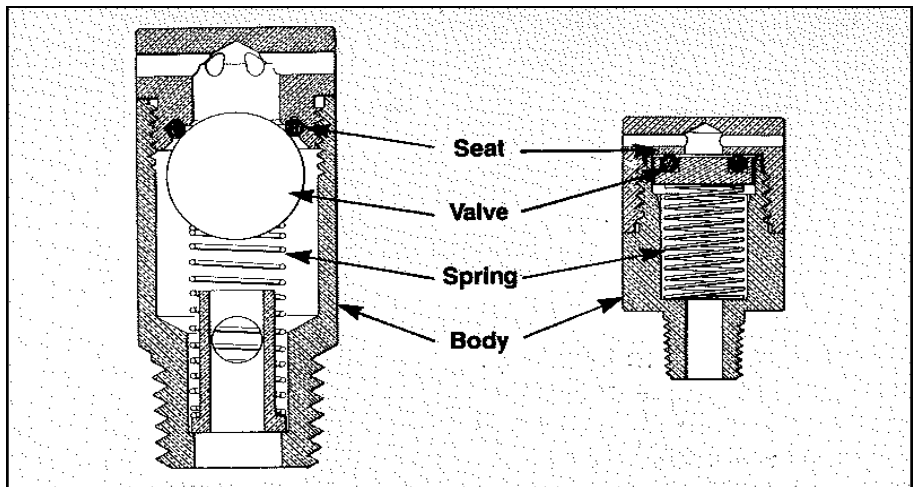





Materials

Model No.	Body	Spring	Valve	Seat
VB 3901	Brass	Stainless Steel	Brass and Silicon	Brass
VB 3902				
VB 3856	Brass	Stainless Steel	Stainless	Silicon
VB 3875				

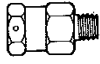
Models are available in four NPT Pipe Sizes. They are 1/8", 1/4", 1/2" and 3/4", all of which are rated for pressures up to 125 PSIG (8.6 Bar), and temperatures to 350° F (180° C). Construction materials are listed in table.

Vacuum
Required
To Open
(Inches of Mercury)

Model No.	Horizontal *	Vertical		
		 Bottom Outlet	 Top Outlet	 No Spring
VB 3901	1.27	1.25	1.75	0.2
VB 3902				
VB 3856	0.77	0.75	1.25	0.3
VB 3875				



***Note on installation:** The preferred method of installation is in the **vertical** position. Horizontal installation should be used only if no other option is available and only above the water line. Vacuum breakers should be placed at the highest practical point.

The table above lists the corresponding "break" points for the various models and positions. MEPCO can custom engineer customer requirements in applications that require other "break" points.



Steam Specialties Adjustable Vacuum Breaker

Features and Benefits

The MEPCO Adjustable vacuum breaker is a simple, reliable device that provides a positive means to automatically relieve or “break” vacuum at a predetermined setting. The MEPCO vacuum breakers are furnished with a 3/8” male NPT and are set at the factory to begin opening at 2” of vacuum. They may be field adjusted from 1” to 28” of vacuum. Maximum operating pressure is 125 lbs. PSIG.



Applications

The MEPCO vacuum breaker is not intended to control or maintain a specific degree of vacuum, but is designed to be applied to prevent damage such as:

1. **Freezing of Coils** resulting from the holding back of condensate due to an induced vacuum.
2. **Collapse of jackets** on steam jackets and kettles caused by vacuum where steam is shut off.
3. **Water hammer** in any heating equipment due to vacuum caused by throttling control valves.

